

WORLD CLASS WINCHES

RELIABLE – DEPENDABLE – UNCOMPLICATED

SEPDURANCE H50



Technical Data

Freespool clutch

Max. pulling force

- bottom rope layer
- top rope layer

Max. rope speed

- bottom rope layer
- top rope layer

Maximum oil pressure

Maximum oil flow

Rope drum diameter

Rope diameter

Rope length

Rope MBL (EN 14492-1)

Number of rope layers

Winch weight

Rope weight

Dimensional drawing (mm)

Product # 73.07-019

Manual

50 kN
32 kN

11 m/min
18 m/min

175 bar
60 l/min

126 mm
14 mm
30 m
≥ 100 kN
4

72 kg
25 kg

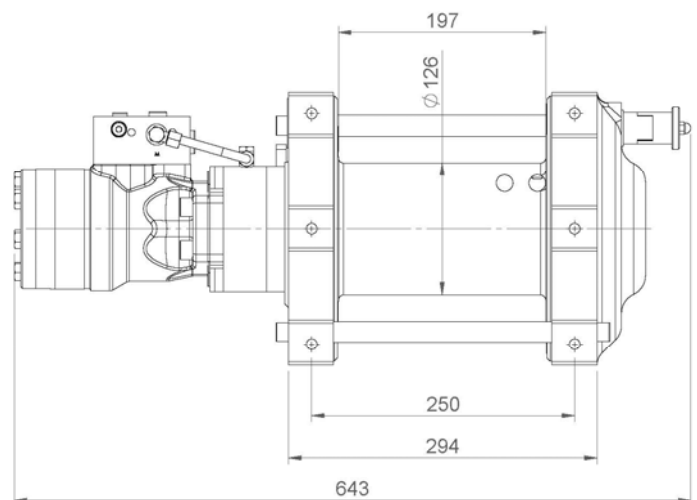
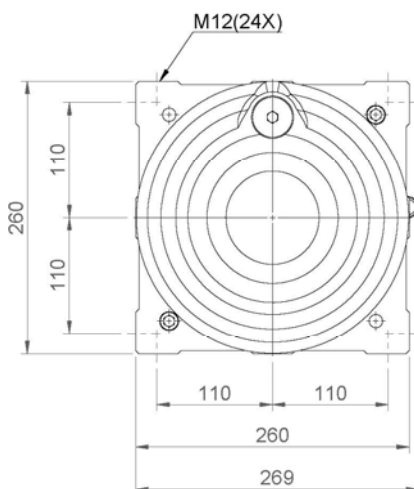

Compliant to EN 14492-1 and SAE J706

